

● Characteristics

1 - RTD - TEMPERATURE SENSOR -

	- Input:	RTD Pt100 (maximum range -50...+200 °C)
	- Output:	4...20 mA current loop HART (2-wire)
	- Voltage supply:	out of current loop (12...40 VDC)
	- Accuracy:	see technical details
	- Process connection:	several options
	- Electrical connection:	several plugs / cable
	- Temperature range:	-40...+85 °C (ambient)
	- Limit value contacts:	2 electronically
	- Adjustment:	keys / software
	- Material:	stainless steel 1.5471 (medium contact)
- Protection:	at least IP65	

● Technical data

Input

Sensor RTD Pt100: -50...200 °C (minimum range: 10°C)

Output

Current signal: 4...20 mA with superimposed communication signal (HART), 2-wire current loop

Current range: 3,8...20,8 mA

Signal on error: 3,8 mA (sensor break, sensor open circuit)

Performance

Sensor: RTD Pt100: Class A / Class B / B1/2 DIN / B1/3 DIN / B1/5 DIN / B1/10 DIN

Measuring amplifier: Accuracy: 0,2K or 0,08% of range

Resolution: 16 Bit / 0,3 µA

Long term stability: 0,05% / year

Filter setting: yes

Transmission behaviour: temperature linear

Turn-on delay time: <5 s

Response time: 1 s

Indicator / limit values: Resolution: -9999...9999 digit

Error of measurement: ±0,2% of range, ±1 digit

Temperature drift: 100 ppm/K

Features: according VDMA 24574-2

Operation: according VDMA 24574-2

Programmable features

Measuring amplifier: measuring range start / measuring range end /

Display: range of indication / time of indication / decimal point / unit (°C/°F) / stabilisation of zero point /

locking of programming / calibration points / TAG number

Limit value contacts: limit value 1 and 2 / hysteresis 1 and 2 / delay times 1 and 2

● Applications

For use in climating, ventilating and heating installations and the whole range of industrial application. With it's two configurable limit value contacts, the integrated display and the numerous electrical connections, the temperature sensor is also suitable for applications with higher requirements.



● Technical data (continued)

Indication

Display:	7 segment, 8,5 mm, red, 4 digits, representation mirror-inverted 180° possible
Head of display:	rotatable approx. 330°
Memory:	minimum / maximum values
Indication:	- measuring value - unit of measurement - control menu
Decimal point:	automatically or manually, dependent on measuring range / unit
	Representation: xxxx / xxx.x / xx.xx / x.xxx / xxx°C / xxx°F

Limit contacts

Electronically:	2 open collectors (30 VDC, 200 mA)
Indication:	1 LED red for each limit value
Voltage across:	<1 V
Settings:	with 3 keys (TouchM-Technology)
Setting range:	switch point and hysteresis: any value within measuring range
Switching delay:	0,0...999,9 s
Failsafe function:	adjustable
Galvanical insulation:	switching outputs are separated from measuring amplifier

Supply

Voltage:	HART current loop: 12...40 VDC VDC
Load:	$R = (U_B - 12 \text{ V}) / 22 \text{ mA}$
Reverse battery protection:	available (no function, no damage)

Ambient conditions

Temperature:	operating range: -40...+85 °C storing: -40...+100 °C
Condensation:	uncritical

Mechanics







Dimensions:	see page 3
Process connection:	1/4" / 3/8" / 1/2" / 3/4" / 1" / 1/4NPT / 3/8NPT / 1/2NPT
Electrical connection:	see page 3
Material:	protecting tube: stainless steel 1.4571 (standard 6x0,5 mm) process connection: stainless steel 1.4571 body: PTB GF30 head of display: polycarbonate (makrolon)
Weight:	approx. 150 g (70 mm, 1/2", M12)
Fitting position:	any
System pressure:	PN 25
Protection:	at least degree IP65 (when electrical connection is plugged)

● Connection M12-plug (example)

Assignment plug M12x1, 8-pole

<p>Current loop 4...20 mA HART</p> <p style="text-align: center;">+ -</p> <table border="1" style="margin: auto;"> <tr> <td style="width: 20px; height: 20px; text-align: center;">1</td> <td style="width: 20px; height: 20px; text-align: center;">3</td> </tr> </table>	1	3	<p>Electronical limit value contacts</p> <table border="1" style="margin: auto;"> <tr> <td style="width: 20px; height: 20px; text-align: center;">2</td> <td style="width: 20px; height: 20px; text-align: center;">4</td> <td style="width: 20px; height: 20px; text-align: center;">5</td> </tr> </table>	2	4	5	<p>Shield</p> <table border="1" style="margin: auto;"> <tr> <td style="width: 20px; height: 20px; text-align: center;">8</td> </tr> </table>	8		
1	3									
2	4	5								
8										

● **Electrical connection**

M12x1	Super Seal	Deutsch	Deutsch	Bajonett	Valve	Cable
						
4-pole 5-pole 8-pole	3-pole	3-pole	4-pole	4-pole	4-pole	2-pole 5-pole

● **Option limit values**

Connection	M12 4-pole	M12 5-pole	M12 8-pole	Bajonett 4-pole	Deutsch 4-pole	Deutsch 3-pole	Super Seal 3-pole	Valve 4-pole	Cable ¹⁾
Limit value (LV)									
1 LV electronically	X	X	X	X	X			X	X
2 LV electronically		X	X						X

1) 2-pole (+shield) without limit value contacts, 5-pole (+shield) with limit value contacts

● **HART Communication**

The HART-Tool is a graphical user interface for the ME series with menu-driven program for configuration. It can be used for putting into operation, configuration, analysis of signals, data backup and documentation of the device.

Operating systems: Windows 2000, Windows XP

Connection via HART interface (modem) with USB interface of a PC or hand-held HART communicator

- Settings:
- Adjustment of output current
 - Limits of measuring range
 - HART TAG number
 - 6-point calibration (linearization)
 - Simulation of output current
 - Linear output signal
 - 2-point calibration
 - Filter function
 - HART address

Please note: When using communication via a HART modem, a communication resistance of 250 Ω has to be taken into account.

● **Dimensions (in mm)**

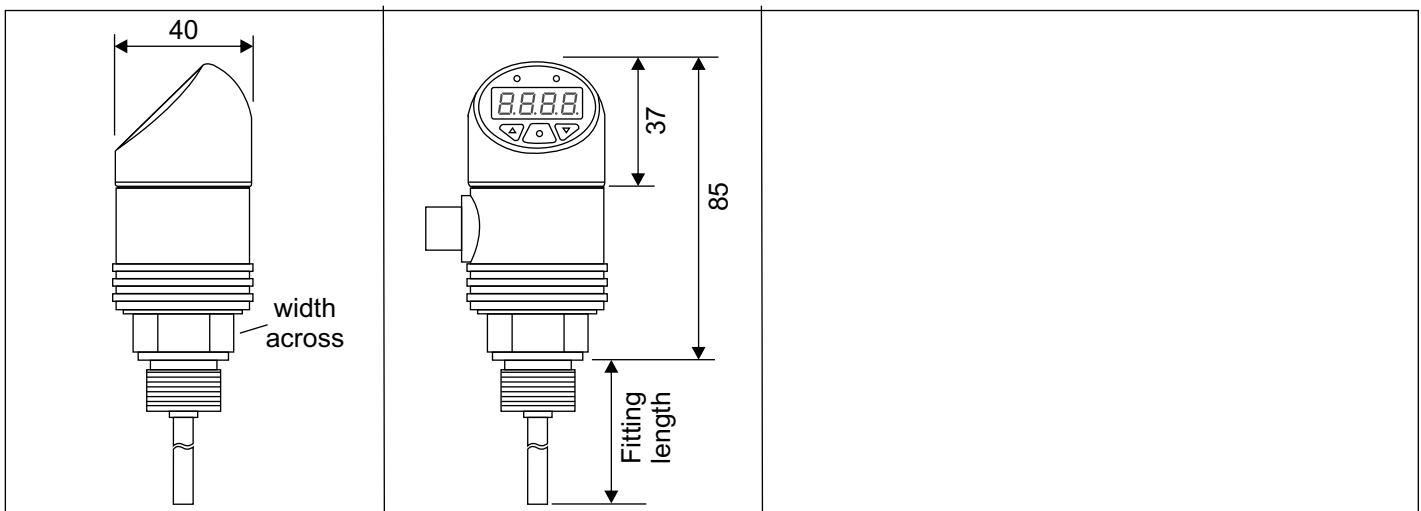

● **Ordering code**

O R X X X X X X - X X X

Input:	RTD Pt100	0																		
Sensor type:	Class A	0																		
	Class B	1																		
	Class B 1/2 DIN	2																		
	Class B 1/3 DIN	3																		
	Class B 1/5 DIN	4																		
	Class B 1/10 DIN	5																		
Protecting tube:	Ø6x0,5 mm	0																		
	other protecting tube (please indicate)	1																		
Fitting length:	50 mm	0																		
	100 mm	1																		
	200 mm	2																		
	250 mm	3																		
	400 mm	4																		
	600 mm	5																		
	1000 mm	6																		
	other length (please indicate)	7																		
Process connection:	1/4"	0																		
	3/8"	1																		
	1/2"	2																		
	3/4"	3																		
	1"	4																		
	1/4NPT	5																		
	3/8" NPT	6																		
	1/2" NPT	7																		
Limit value contacts:	2x electronically (standard)	0																		
	1x electronically	1																		
	without	2																		
Electrical connection:	M12, 4-pole	0																		
	M12, 5-pole	1																		
	M12, 8-pole	2																		
	Deutsch DT04, 3-pole	3																		
	Deutsch DT04, 4-poe	4																		
	Super Seal 1.5, 3-pole	5																		
	bayonet (DIN), 4-pole	6																		
	valve plug, 4-pole	7																		
	cable, 2 m	8																		
Configuration:	factory setting ¹⁾	0																		
	customized (please indicate) ²⁾	1																		
Other:	special model																			0

1) Measuring range: / Indicating range

2) The possibilities which are specified in the technical data can be selected. For not given values the details of factory-set are used.

Accessories:

Interface HART, USB, software

Order No.: